

StyroPress®



Big feeding opening



Function

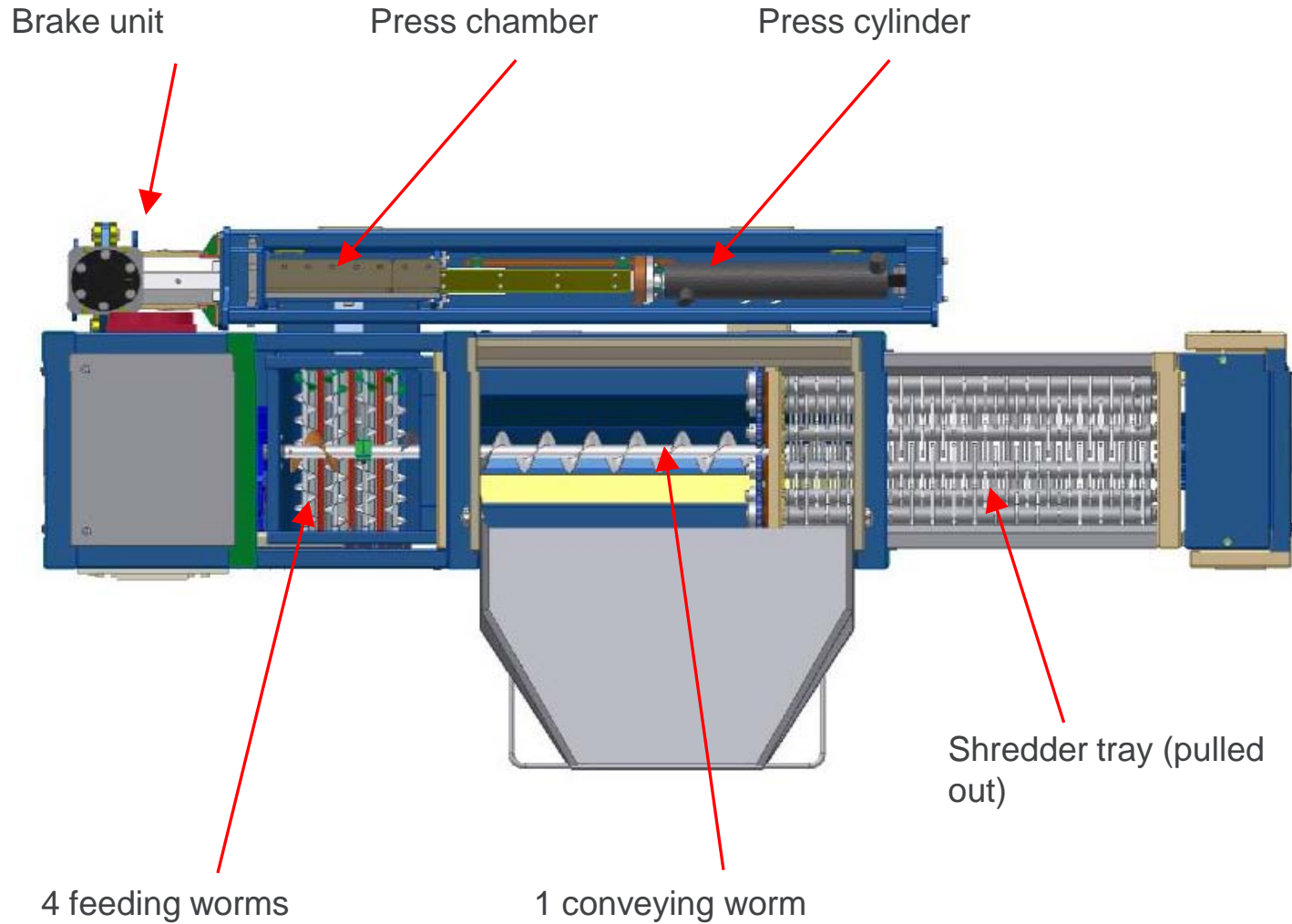

Material insertion

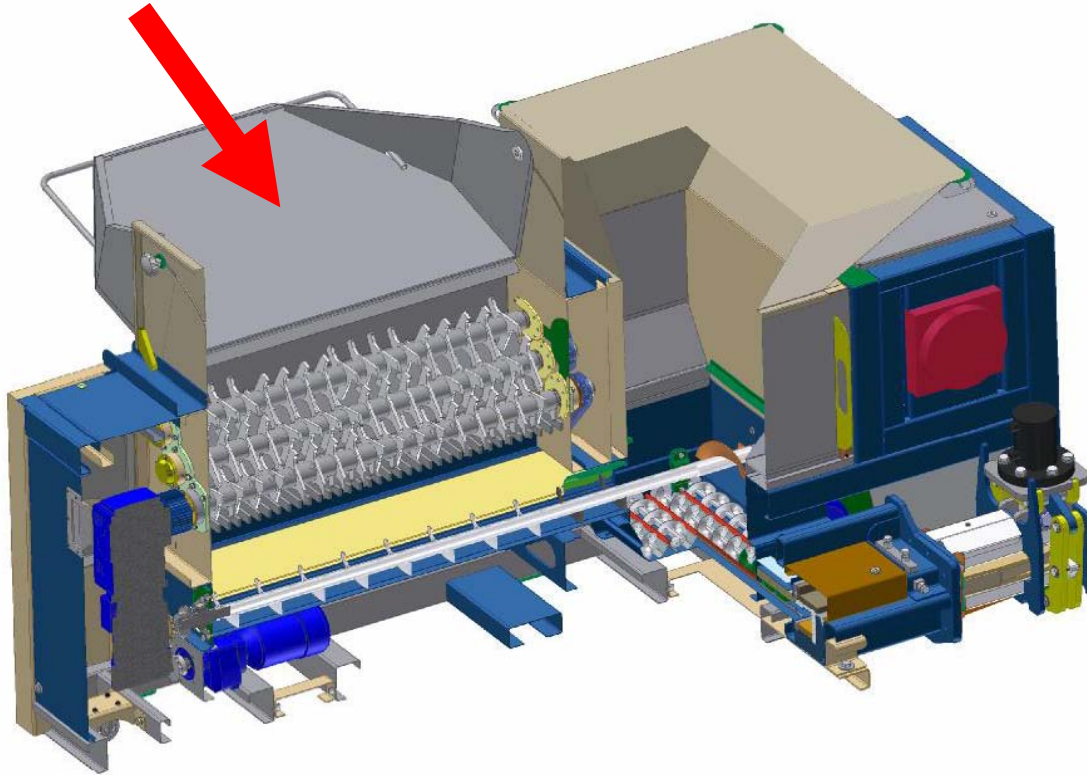

EPS/XPS dust, globules, crumbles and shapes up to 1500 x 1200 x 500mm can be put into the shredder. Shredding performance : ~ 100kg/h

**Less time intensive –
labour costs savings!**

Pre-crushing by 6 shafts

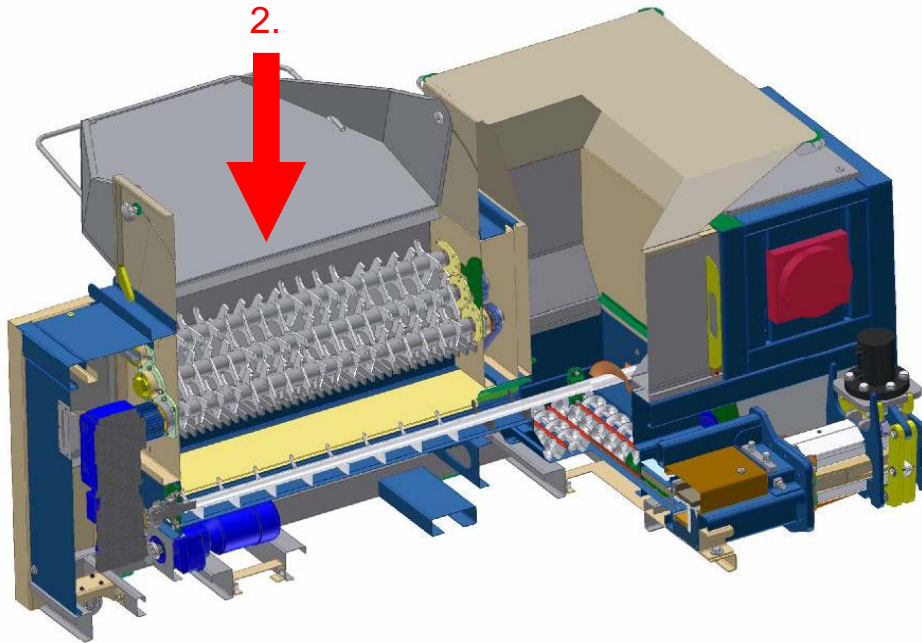

Material will be drawn in and hacked automatically.
The granularity will be 10 – 30mm (material dependent)

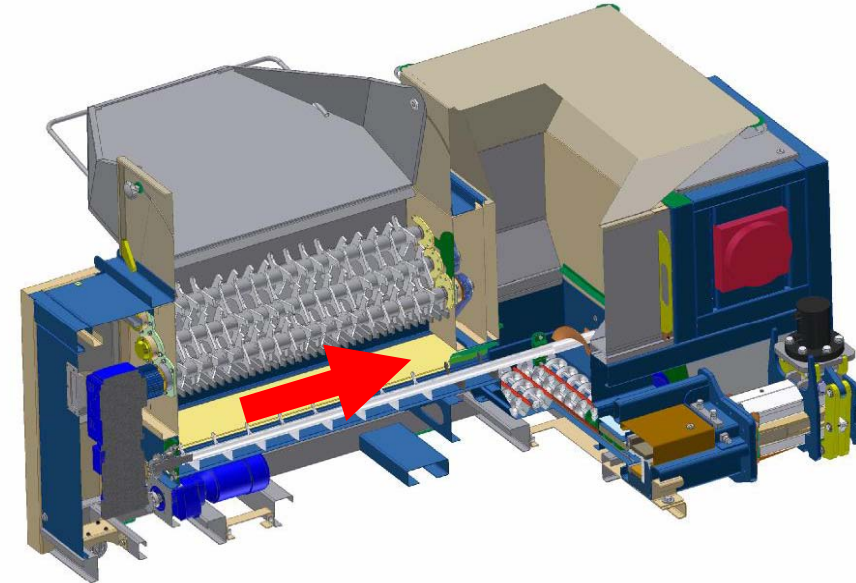

The conveying worm underneath the shredder pushes the material towards the buffer.

Easy handling!

Extendable buffer



Extendable buffer



Silo system (optional)

There is a 7 cbm steel silo system available. When filled, the machine can run 4 - 5 hours without supervision. Your staff has more time for the core business. **Fully automatic press process – time & labour cost savings!**

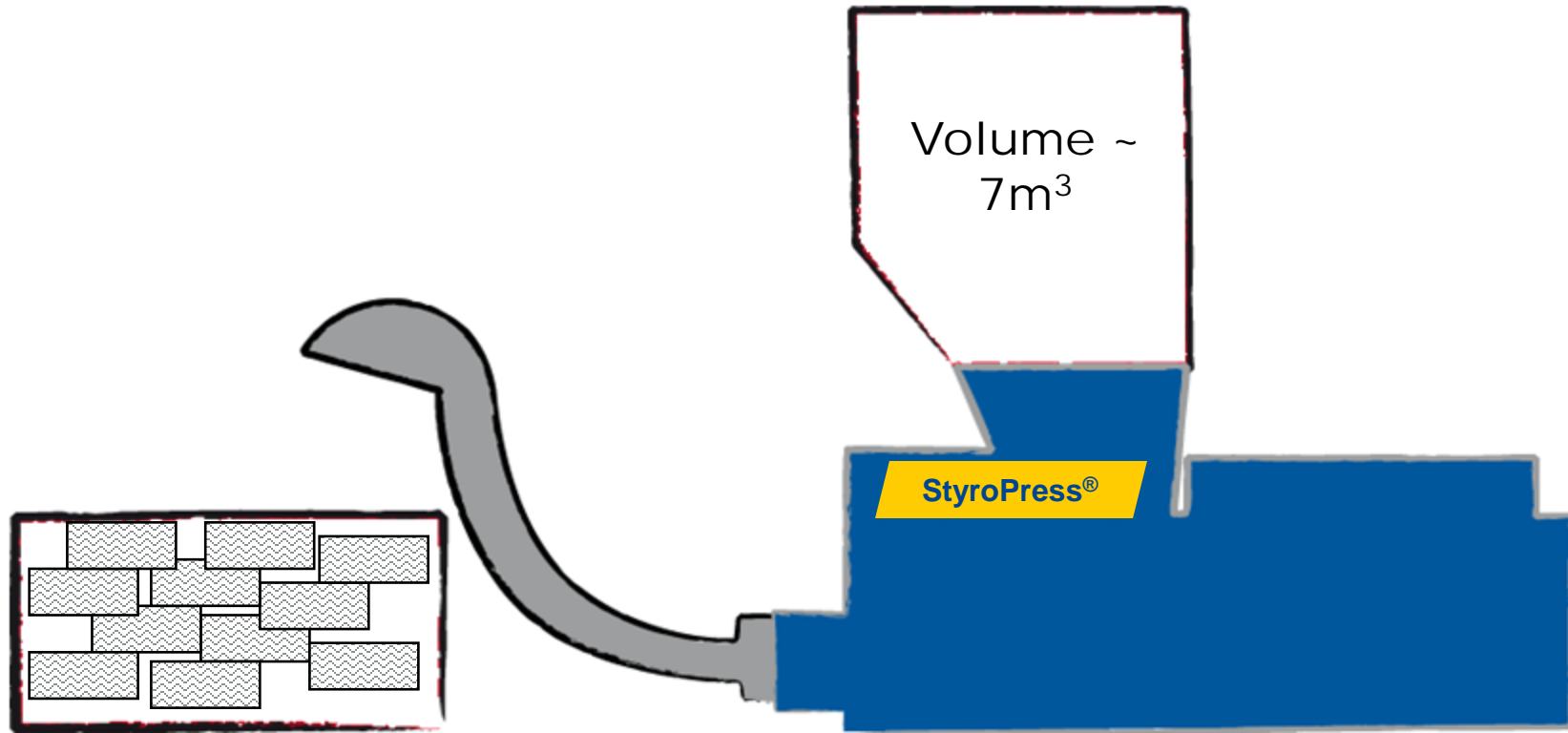

Buffer feeding worms

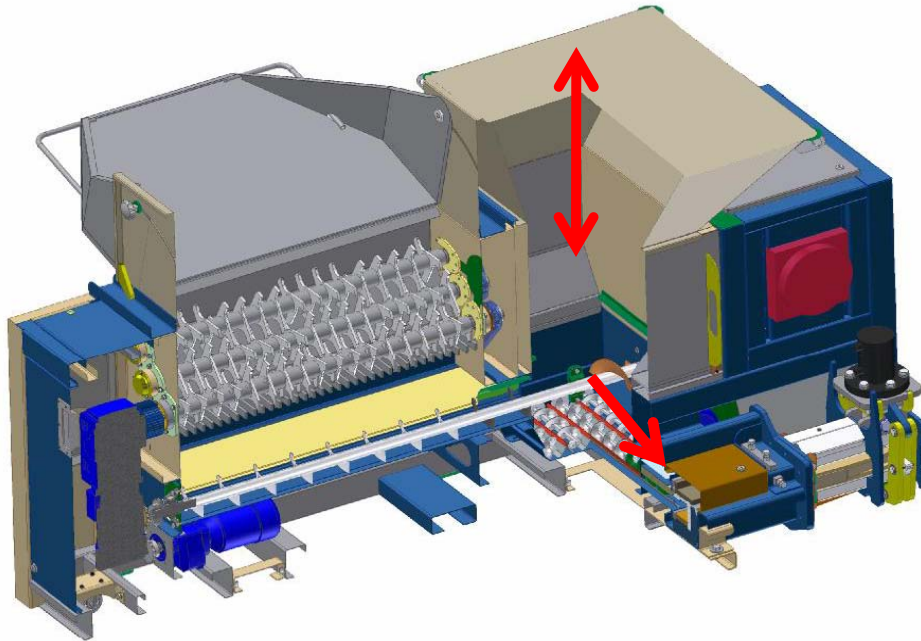

The buffers stores the hackled material until it is compacted. The machine fills itself from the buffers content with 4 feeding worms.

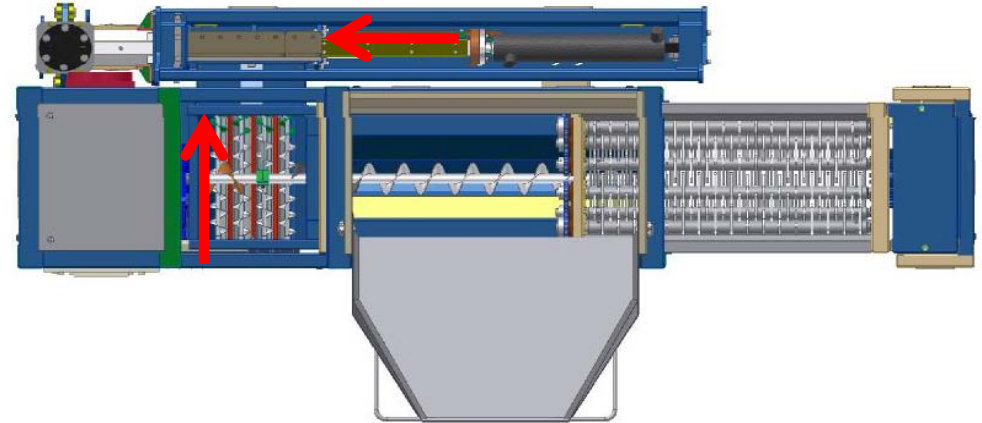

Four feeding worms push the material into the press chamber. The press cylinder compacts the material with a pressing force of 250 kN.

Innovative brake concept

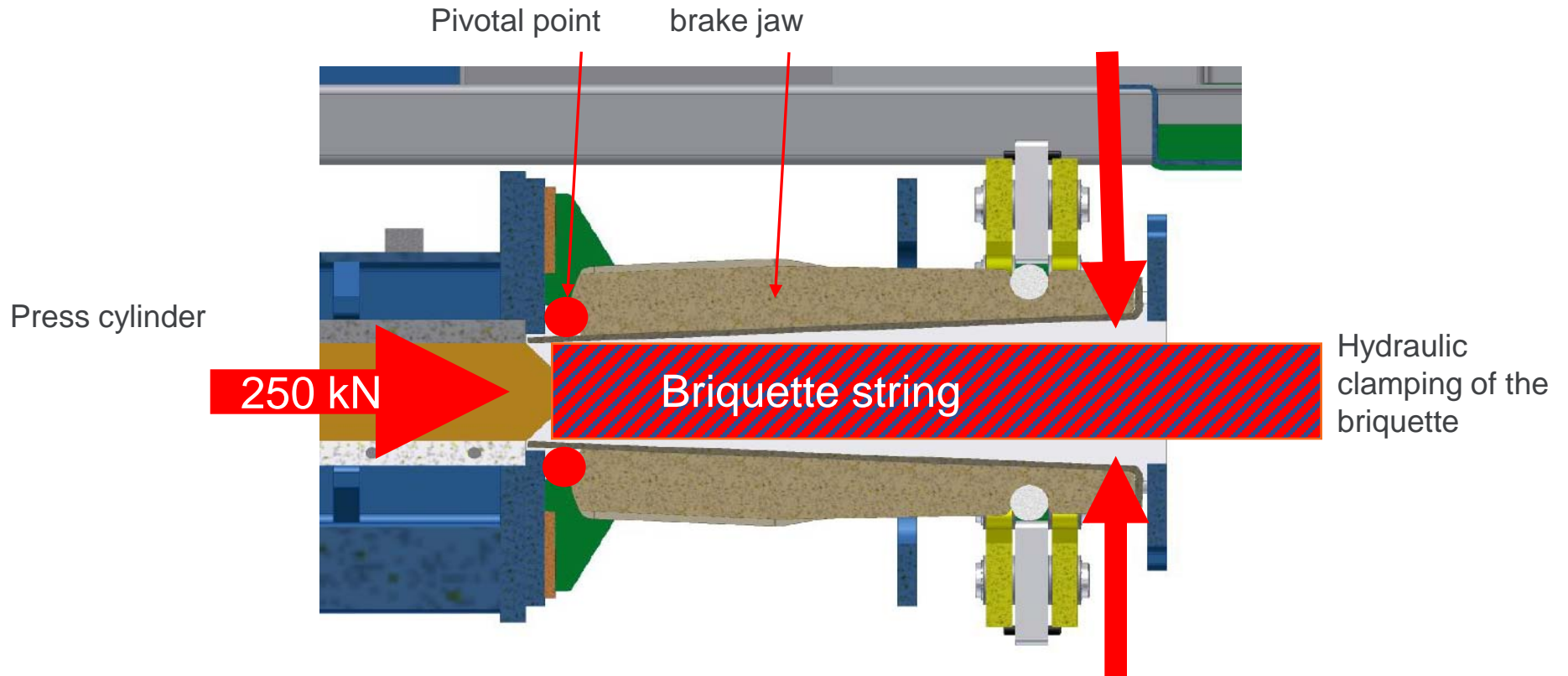

Due to the conical square section of the Brake channel, the briquette output is guaranteed.
This system cannot get clogged !

Material output

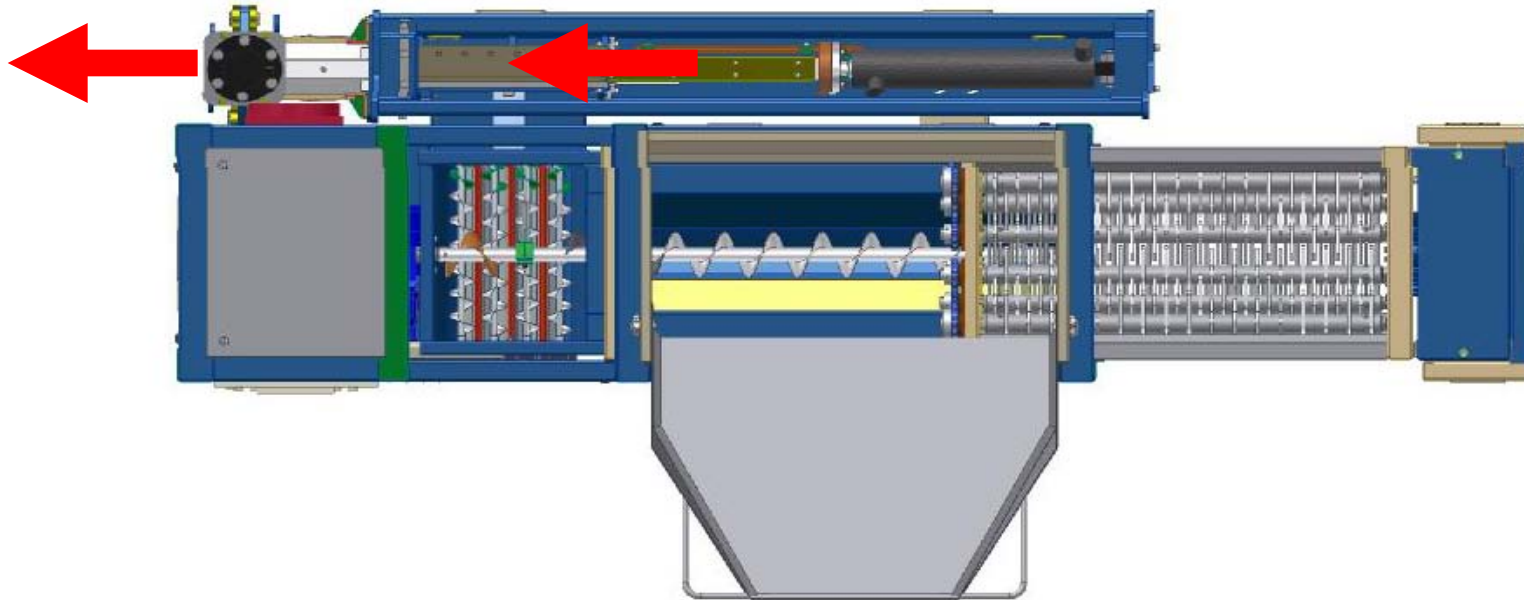

The press chambers content is press by the com-pacting cylinder, against the existing briquette string and through the clamps of the brake.

StyroPress®



Pressing unit

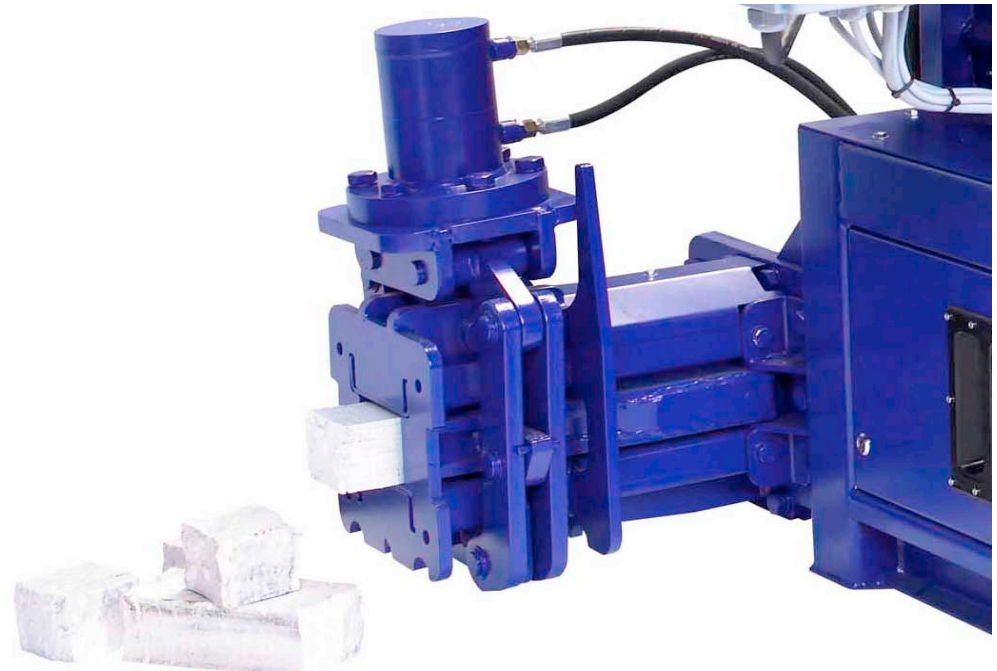

Brake unit

Volume reduction of up to 97%



Advantages of briquettes:

- Much more space
- Improvement of logistics / transports
- Reduction of transportation costs
- Very low fire load, no problems with fire protection regulations
- No loose material flying around at windy wether
- High revenues for briquettes, regional and worldwide

**Highest revenues of
up to 650 €/t!**

Space saving

**Space saving due to a volume
reduction of up to 97 %**

Before: 1.000 m³



After: 30 m³



Reduction of transportation costs

Reduction of transportation costs due to a volume reduction of up to 97 %

Loose material: you need 80 containers each 40 m³ for 24 t loose material

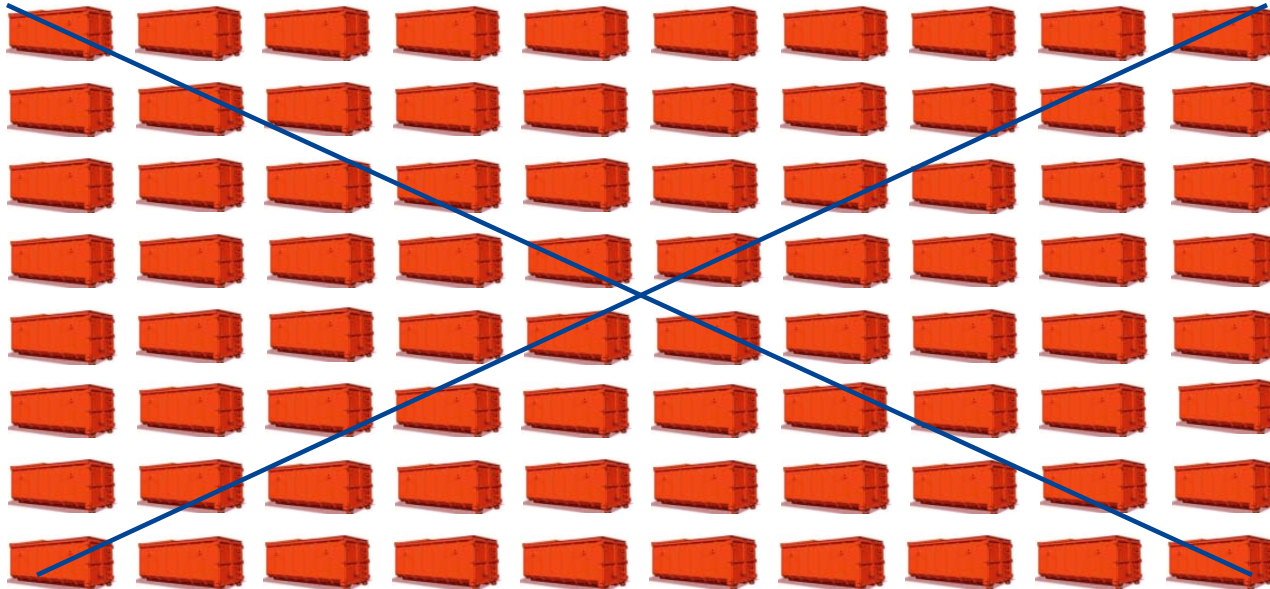

Compacted material: You need just ONE container for 24 t EPS (Styropor) in briquettes



Comfortable and flexible



Easy to transport with forklift pockets

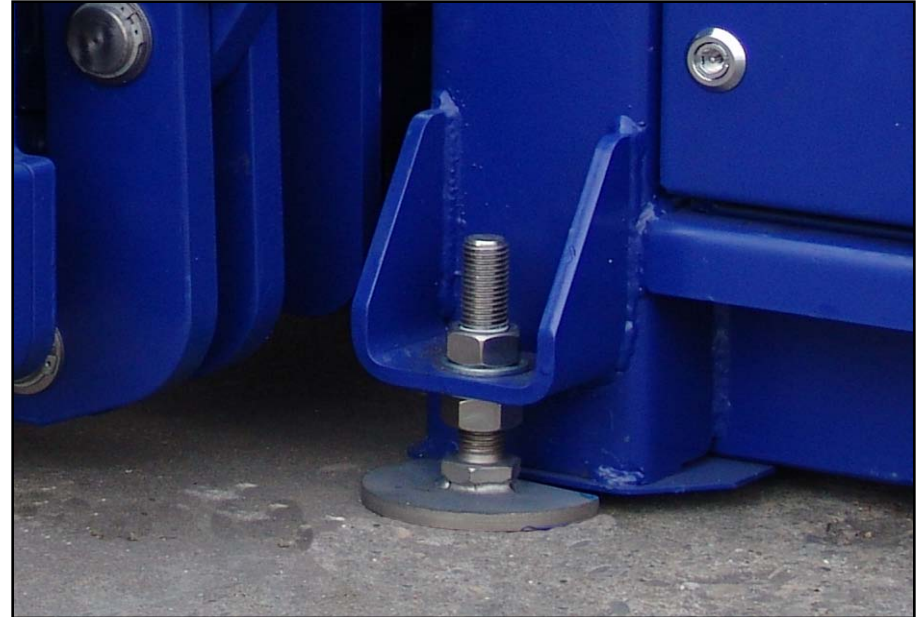

No basement needed due to adjustable feed

Materials, that are useable for StyroPress®



Symbol for PS / EPS (Polystyrol)

Insulation material and moldings, packaging material, housings, containers

- All plastic parts where this symbol is graven
- EPS and XPS moldings and their crumbs or dust (important clean and dry material)

Determination of materials:

Check identification symbol:	(6 resp. 06 is EPS). Attention There is also 6´ material, that is not compressible (see below)
Thumb pressure test (recommended):	EPE/EPP will reset / spring back, at EPS/XPS the depression will remain!
Bending test :	EPE/EPP can be bended easily and elastic and will spring back, EPS/XPS is stiffer and springs only minimal, with more bending force it will break.
Crumbling test:	When crumbling EPS, the grit will stick at your hands. EPE/EPP grit will fall down. XPS cannot be crumbled.
Fire test :	EPS burns with an orange-yellow flame and black smoke. EPE/EPP burns light yellow with a bluish frame and produces pale up to light grey smoke.
Surface test:	EPS has a matt surface and a blunt grip, wrong EPS and EPE/EPP have shiny surfaces with a slippery grip.

Difference EPE - EPS (thumb pressure test !)



EPE

EPS

Briquette quality

When recycling the EPS- briquettes, they are crushed again in a shredder and is being melted in an extrusion machine. The contaminants in the briquette can clog the filters in the extrusion machine and will decrease the quality of the regrind.

It is absolutely essential to fill pure and clean material into the press to get a high- grade briquette!



Recyclers do not have any problem with:
Skin deep discolorations on the outer surfaces, may be caused by machine wear, humidity, corrosion or coloured material. Very low amount of contaminants like other plastics, foils or stickers

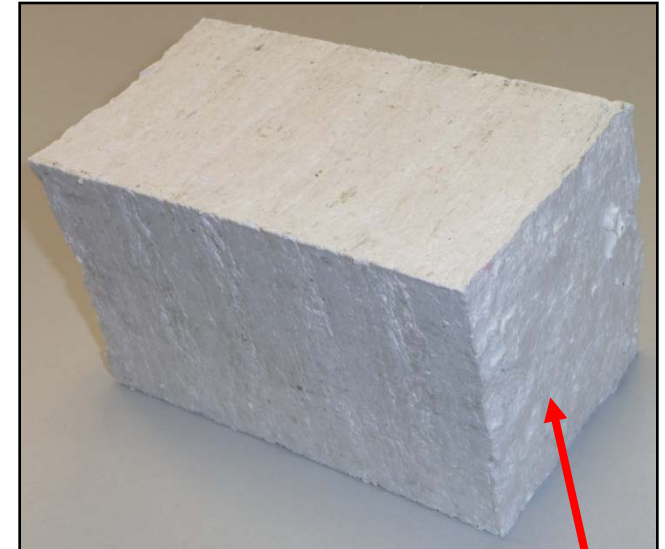

This is a really good quality.

For highest revenues it is essential that the CORE is pure and clean!

Briquette quality

These briquettes are normally not accepted or payed for by the recyclers because they cause problems to the extrusion machines :



Bigger amounts of other plastics like foils, tapes or stickers.



Wood scraps or wood dust



Contaminats of expanded or not expanded plastics like PE, PP, PA, PUR

Briquette quality

To avoid these contaminants in the briquettes and get higher revenues, the wrong materials should be sorted out before they get into the press:



Sort out: PU- Foam and foam film



Remove and sort out: Paper and sticker



Sort out: Film remains and PP- material



Printed material : no problem

Recycling von EPS/XPS Briketts

The usual recycling method for EPS- or XPS- briquettes is the thermic reworking in a so-called extrusion machine. After precrushing, the briquettes will be melted (plastified) in the extruder. The melt will be degassed and filtered. Referring to customers demands, some additives (masterbatches) could be added to achieve special characteristics, e.g. impact strength. The extruder presses small lenticular balls, the so-called Polystyrene- regrind, out of the melt. This is the raw material for the next step, you can produce picture frames, CD- trays or clothes holders out of it.



Material feeding towards the shredder.



The material brought by the conveyor is hacked here and drawn out by a vacuum system (see tube).

The end-product – polystyrene regrind



Potential customers for StyroPress®

Important branches:

- Big furniture manufacturer:

www.xxxlutz.at

www.roller.de

www.kingfisher.com

www.leiner.at

www.hoeffner.de

www.conforama.ch

www.ikea.com

www.kika.at

more under: www.furniture.eu

www.poco-domaene.de

www.homeretailgroup.com

- (Polystyrol) Packaging material producer

Big EPS manufacturer:

GR: www.epshellas.com

E: www.anape.es

CH: www.epsschweiz.ch

NL: www.stybenex.nl

PL: www.styropiany.pl

SE: www.plast-kemi.se

I: www.epsass.it

A: www.gph.at

BE: www.styfabel.be

UK: www.eps.co.uk

NOR: www.pif.no

FIN: www.eps-eriste.fi

P: www.acepe.pt

CZ: www.epscr.cz

F: www.snpafrance.fr

D: www.styropor.de

DK: www.plastindustrien.dk

SLO: www.epssr.sk

- Waste manager

- Electronic wholesaler and retailer

www.euronics.com

www.electronicpartner.com

www.media-markt.com

www.dsgiplc.com

www.expert.org

www.argos.co.uk

Companies that have 4 to 14 t EPS or XPS per month.

Even if the amount of material is not sufficient, the StyroPress can be economically due to its handling advantages and savings in logistic costs.

Comparison with a screw compactor

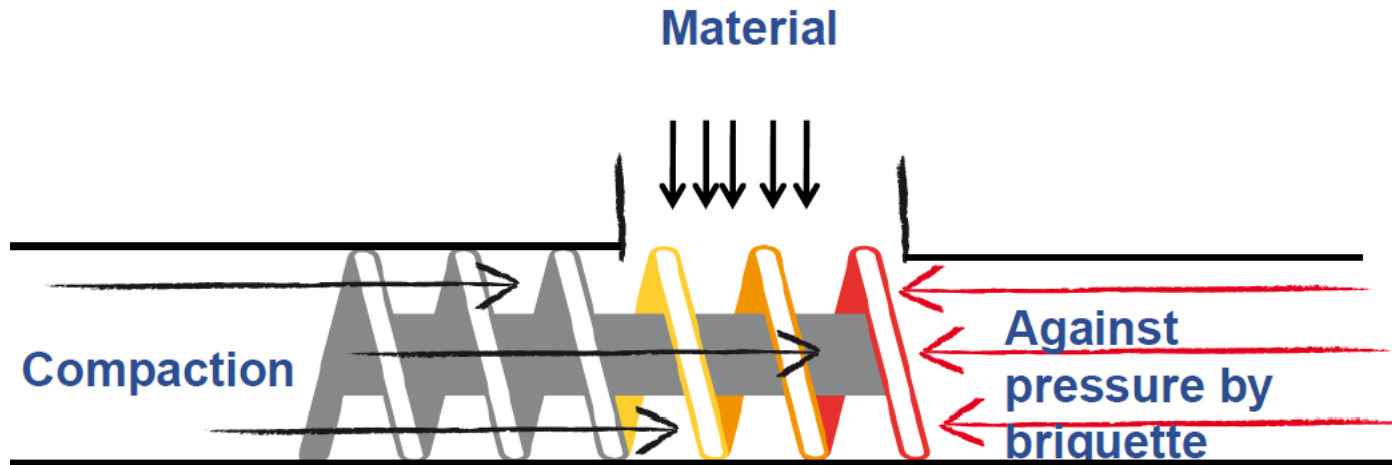

All screw compactors - due to the working-principle - suffer from material-overheating due to frictional heat. This leads to **overheated material and jamming**.

The StyroPress® has no heated material problems – it works hydraulically.

Further more you have downtime due to **cooling down and repair-time** du to jamming of the screw. Finally the screw compactor needs to be filled manually because it has no buffer cache. This leads to **long processing times and higher labour input**.

The StyroPress® is more effective and the briquette is 3 times more dense.

Comparison of throughput

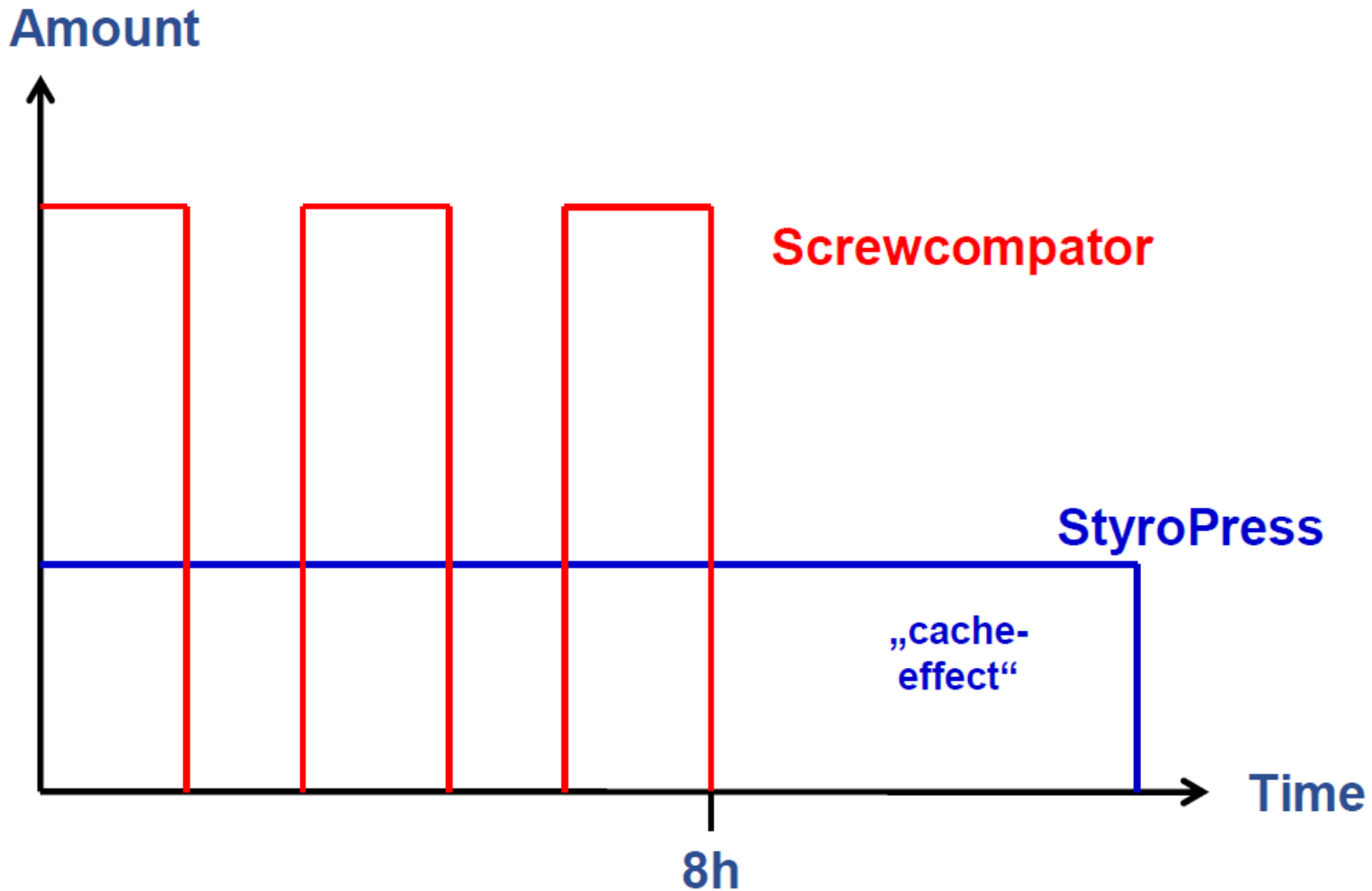

Measurable USP's of StyroPress®

	Strautmann StyroPress®	Heger GZV-S-A400	Runi SK 370
Briquette density (kg/m ³)	700	< 250	< 250
Truckload	24 t	9 t	9 t
Availability	98%	thermic problems	
Throughput (kg/h)	30	> 100	> 100
Space (m ²), Length (m)	5 / 3,5	9 / 6,8	7,5 / 5,5
Continous operation possible	yes	no	no
Payment (Euro/t)	400	180	180

- ✓ **no overheating of material or cooling down / jamming**
- ✓ **operation 24/7 possible**
- ✓ **high capacity with cache (buffer silo)**
- ✓ **less transportation costs due to highest density -> full container / truckload**
- ✓ **less labour costs**
- ✓ **safe and simple to use**